

GalCen[®]
herrajes con clase...

Catálogo
2019

Mejora tu estilo
Refleja tu clase
Herrajes para cristal templado
línea arquitectónica



Perfil Corporativo

Empresa 100% mexicana, fundada en el año 2012 con sede en la ciudad de Aguascalientes Ags. Ubicada estratégicamente en el centro del país para una mayor facilidad de distribución, con el principal objetivo de satisfacer a nuestros clientes, y proveedores con productos de la más alta calidad y excelente servicio. Innovando en nuestra industria y generando un magnifico ambiente de trabajo con el mejor material en acero inoxidable para cristal templado.



Misión

Nuestra empresa esta forjada en una unión de esfuerzos, luchas y tenacidades que nos han llevado a obtener una cimentación sólida que nos permite ofrecer seguridad, confianza y satisfacción en la distribución de herrajes para cristal templado.

Defendiendo el principio de que el cliente es lo mas importante dentro de nuestra organización.



Visión

Ser una empresa modelo y líder con reconocimiento y posición nacional en la comercialización de herrajes para cristal templado a la vanguardia del cliente en innovación, calidad, servicio y atención.



Valores

G arantía en nuestros productos

A tención personalizada

L ealtad y liderazgo

C alidad y confianza en nuestro servicio

E sfuerzo, esmero y entrega

N osotros somos tu mejor opción



ÍNDICE

Bisagras	01
Línea económica	02
Conectores	03
Clips	04
Grapas	
Conectores	05
Entrepaños	
Entrepaño colgante	06
Sujeción señáleticas o fijos	07
Marquesinas	
Acceso	08
Bisagras hidráulicas	09
Puntos de giro	
Jaladeras	10
Jaladeras curvas	11
Pomos	
Pasamanos	12
Postes	13
Soportes	14
Brazo estabilizador	
Arañas	15
Arañas porta costilla	16
Rótulas	
Canceles	17
Cancel escuadra	18
Cancel corredizo	
Sistemas	19
Corredizo embalado	20
Corredizo	
Plegable serie 2000	21
Plegable serie 3000	22
Chapas	23
Chapas sin resaque	24
Perfiles de PVC	25
Accesorios para vidrio	26
Cortavidrios	27



2019

El cristal necesita resaque para su fijación, se recomienda adquirir el producto antes de perforar el cristal.



Bisagras

Bisagras

Nuestras bisagras hechas con el mejor material en acero inoxidable y zamac, le brindarán un diseño elegante, neutro, de carácter práctico y fácil instalación. Así como también variedad de diseños que se ajusten a su gusto y necesidades.

Información

Material: Acero inoxidable
Acabado: Satin, Cromo
Soporte: 30 kg.
Cristal de 8 a 12 mm.

Acero inoxidable

SABÍAS QUÉ?

El vidrio fue descubierto por los egipcios aproximadamente en el año 3000 A.C.



GC-B001

Muro a vidrio de 90°

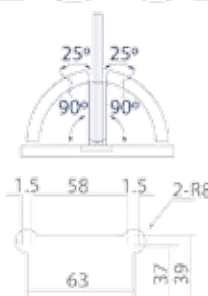

GC-B002

Vidrio a vidrio de 135°

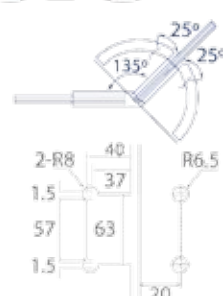

GC-B003

Vidrio a vidrio de 180°

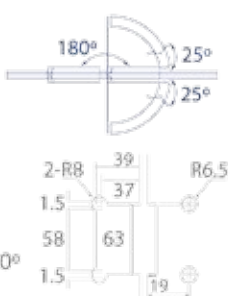

GC-B004

Vidrio a vidrio de 90°

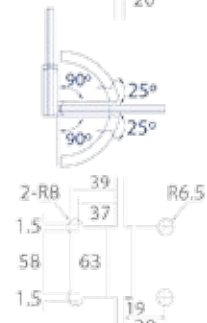

GC-B005

Pivote (piso o techo) 360°



GC-B001DES

Descentrada

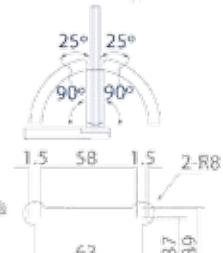



Línea Económica

Galcen® se preocupa por su economía y le ofrece una línea económica en bisagras, sin dejar de lado la calidad que nos caracteriza y que sólo usted se merece.

Información

Material: Zamac

Acabado: Satin, Cromo

Soporte: 30 kg.

Cristal de 8 a 12 mm.

GC-B011PETIT: Cristal de 6 mm. Soporte: 15 kg.

GC-BS01 y GC-BS02: Cristal de 6 a 10 mm.

Soporte: 30 kg.

Acero inoxidable

Zamac

GC-BS01



Muro a vidrio de 90°

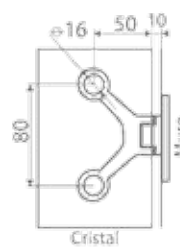

GC-BS02



Vidrio a vidrio de 180°

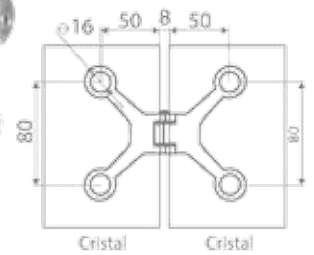

GC-B011



Muro a vidrio de 90°

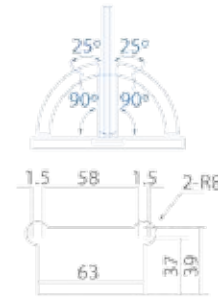

GC-B012



Vidrio a vidrio de 135°

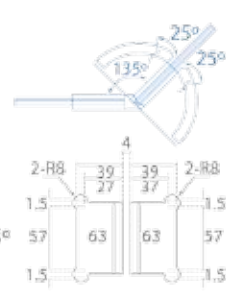

GC-B013



Vidrio a vidrio de 180°

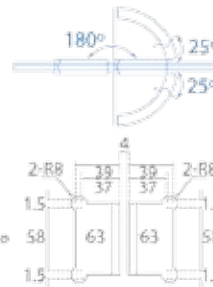

GC-B014



Vidrio a vidrio de 90°

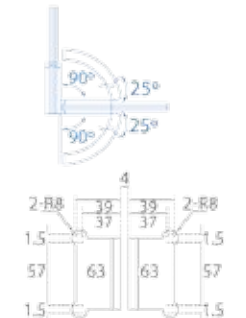

GC-B011DES



Descentrada

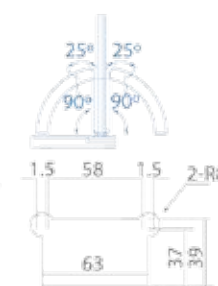

GC-B011PETIT



Muro a vidrio



GC-B011C



Muro a vidrio de 90°

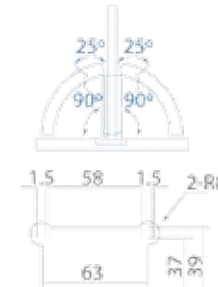

GC-B012C



Vidrio a vidrio de 135°

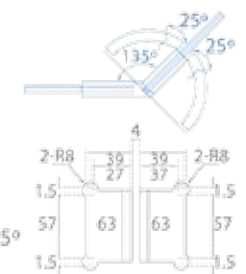

GC-B011DESC



Descentrada

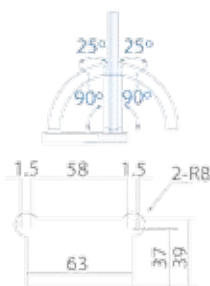

GC-B013C



Vidrio a vidrio de 180°

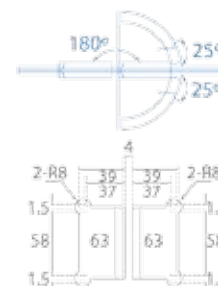

GC-B014C



Vidrio a vidrio de 90°

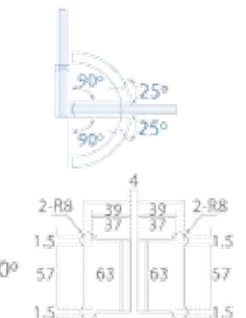

GalCen®
herrajes con clase...

El cristal necesita resaque para su fijación, se recomienda adquirir el producto antes de perforar el cristal.

Conectores

Conectores

Nuestros clips, conectores, grapas y herrajes para sujeción, buscan ofrecerle un espacio lleno de elegancia y estilo, además de que se adaptan a cualquier diseño arquitectónico. Le brindan una viable funcionalidad a sus proyectos, pero sobre todo la fiabilidad y resistencia del mejor material con el que están elaborados.

Información

Material: Acero inoxidable
Acabado: Satin, Cromo
Cristal de 8 a 12 mm.

SABÍAS QUÉ?



Harry Brearley (1871-1948)
Metalúrgico inglés, descubrió el acero inoxidable en 1913.

Acero inoxidable

GC-C010A



Muro a vidrio sencillo

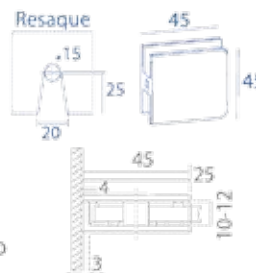

GC-C012A



Muro a vidrio con base lateral de 90°

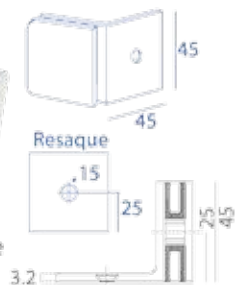

GC-C013A



Vidrio a vidrio de 90°

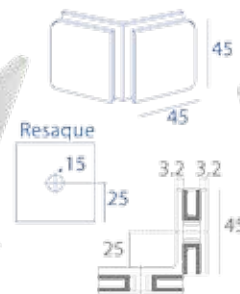

GC-C014A



Vidrio a vidrio de 135°

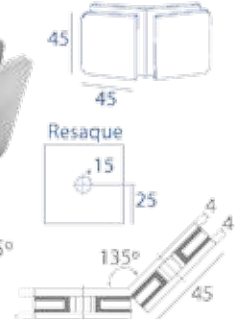

GC-C015A



Vidrio a vidrio de 180°

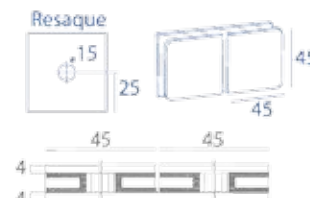



Clips

Información

Material: Zamac
 Acabado: Satin, Cromo
 Cristal de 8 a 12 mm.



Grapas

Información

Material: Zamac / acero inoxidable
 Acabado: Satin
 Cristal de 8 a 12 mm.
 Petit: de 6 a 12 mm.

Zamac

GC-C010



Muro a vidrio sencillo

Resaque



GC-C011



Muro a vidrio doble fijación

Resaque

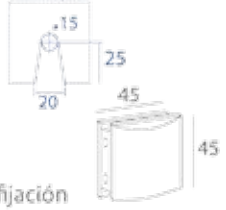

GC-C012



Muro a vidrio con base lateral de 90°

Resaque

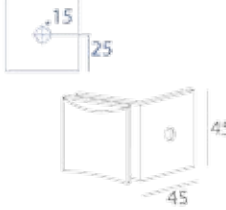

GC-C013



Vidrio a vidrio de 90°

Resaque

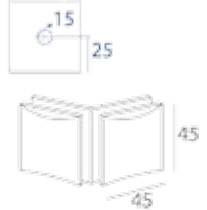

GC-C014



Vidrio a vidrio de 135°

Resaque

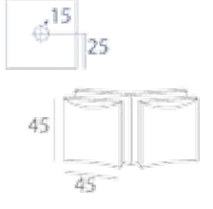

GC-C015



Vidrio a vidrio de 180°

Resaque

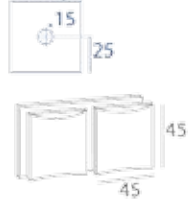

Zamac

GC-C025



Grapa base plana

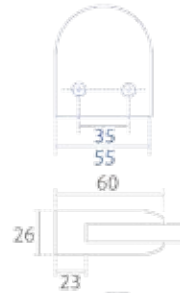

GC-C026



Grapa base curva

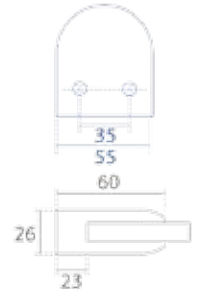

GC-C025PETIT



Grapa mini base plana

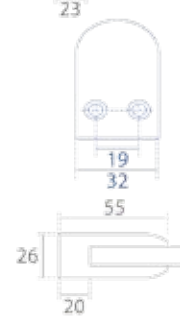

GC-C026PETIT



Grapa mini base curva

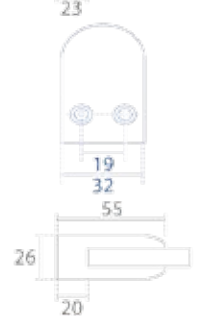

Acero inoxidable

GC-C025A



Grapa cuadrada base plana

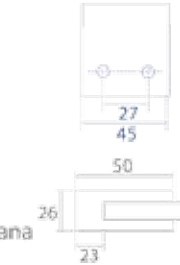

GC-C026A



Grapa cuadrada base curva

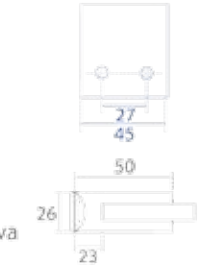

GC-C027



Grapa lateral inicio y final



GC-C028



Grapa lateral intermedia

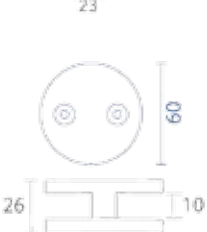



Conectores

Información

Material: Acero inoxidable
 Acabado: Satin
 Cristal de 8 a 12 mm.

Acero inoxidable

GC-C016



GC-C017



GC-C018



GC-C019



GC-C020



GC-C021



GC-C022



GC-C023



Clips

Información

Material: Zamac
 Acabado: Satin, Cromo
 Cristal de 8 a 12 mm.
 El cristal no necesita resaque para su fijación

Zamac

GC-C029 A GC-C032

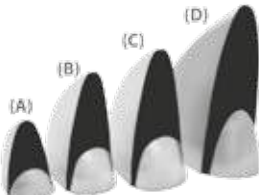

Punta pelicano

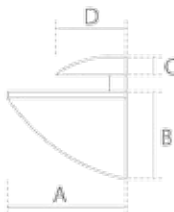

Clave	A	B	C	D
GC-C029	4.0cm	3.2cm	0.4cm	16mm
GC-C030	5.0cm	4.0cm	0.6cm	20mm
GC-C031	6.5cm	4.7cm	0.8cm	25mm
GC-C032	10.0cm	7.0cm	1.2cm	40mm

GC-C033



Cuadrado

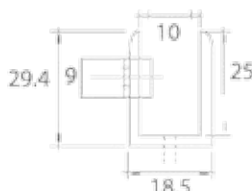

GC-C034



Rectangular

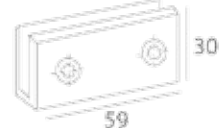

GC-C35



Media luna

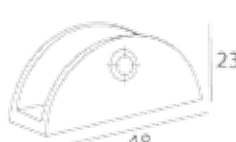

El cristal necesita resaque para su fijación, se recomienda adquirir el producto antes de perforar el cristal.

Entrepaño colgante



Acero inoxidable y aluminio

Información

Material: Acero inoxidable
Acabado: Satin
Cristal de 8 a 12 mm.

GC-C036



Gancho



GC-C037



Base móvil superior

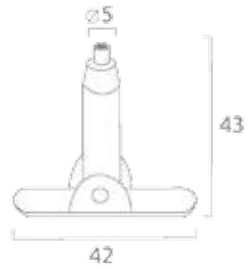

GC-C038



Base fija superior



GC-C039



Base intermedia



GC-C040



Base inferior



GC-C041



Soporte intermedio

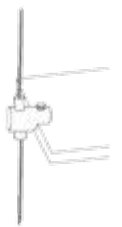

GC-C042



soporte doble intermedio

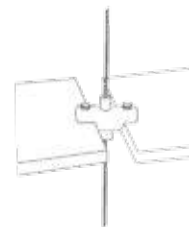

GC-CABLE



Cable





Sujeción

Información

Material: Acero inoxidable
 GC-S113: Aluminio
 Acabado: Satin
 Cristal de 8 a 12 mm.

Acero inoxidable y aluminio

GC-S101 A GC-S106



Cilindrico para señáletica

GC-S105



Cilindrico con tensor

GC-S111



vidrio a vidrio

GC-S113



Ángulo para fijos



Clave	A	B
(A) GC-S101	2.0cm	1.9cm
(B) GC-S102	4.5cm	1.9cm
(C) GC-S103	6.7cm	1.9cm
(D) GC-S104	4.6cm	3.0cm
(E) GC-S106	2.5cm	3.0cm

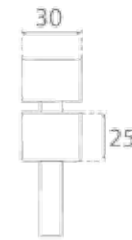

GC-S110



Muro a cristal de lujo

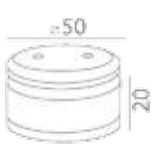

GC-S112



Muro a vidrio

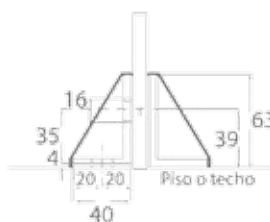
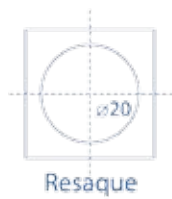

El cristal necesita resaque para su fijación, se recomienda adquirir el producto antes de perforar el cristal.



Nuestros herrajes para marquesinas hechos con un alto grado en acero inoxidable. Para una mayor durabilidad incluso en los entornos mas duros, le brindan una facil instalacion, además de un aspecto elegante, mejorando el diseño de cualquier estancia.

Marquesinas

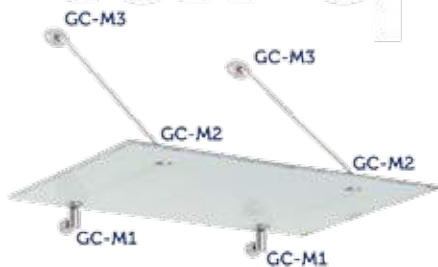

Información

Material: Acero inoxidable
 Acabado: Satin
 Cristal de 8 a 12 mm.

Acero inoxidable

GC-M1



Muro a vidrio



GC-M2



Vidrio a varilla



GC-M3



Muro a varilla

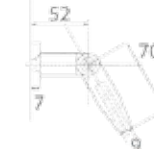

GC-MV



Varilla



El cristal necesita resaque para su fijación, se recomienda adquirir el producto antes de perforar el cristal.



Acceso

Herrajes de acceso

Busca una entrada elegante con nuestros herrajes de acceso, que le ofrecen soluciones innovadoras que delimitan, amplían o revalorizan cada espacio, además de una fácil instalación, material de la mejor calidad y el estilo que su usted necesita.

Información

Material: Acero inoxidable
Acabado: Satin
Cristal de 9 a 12 mm.

SABÍAS QUÉ?



Para la fabricación del cristal templado, el vidrio se somete a un calentamiento muy alto y un enfriamiento rápido

Acero inoxidable

GC-P100



Inferior

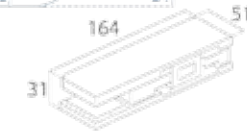

GC-P120



Superior con pivote



GC-P110



Superior

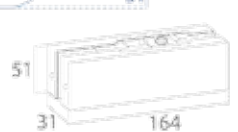

GC-P130



Chapa con cilindro



GC-P150



"L" con pivote y antepecho



GC-P151



"L" con pivote, antepecho y portacostilla

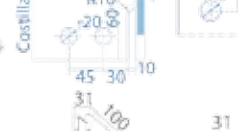

Bisagras hidráulicas

Estructura



Información

Material: Acero inoxidable
 Acabado: Satin
 Incluye accesorios para puertas de aluminio.

GC-HID01

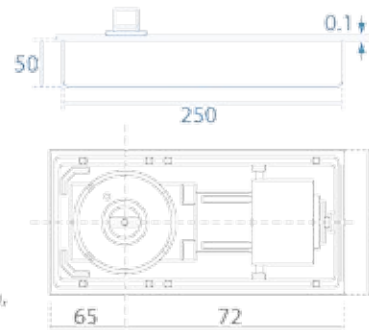

GC-HID02

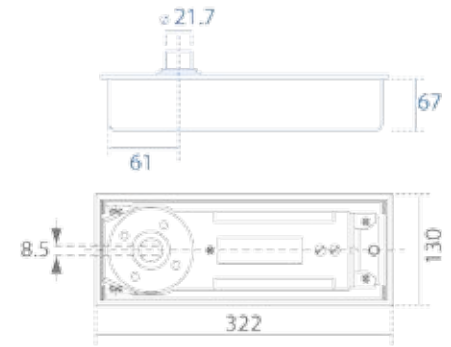

GC-P100HID



inferior hidráulico 100kg.

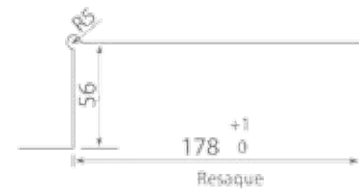

NOTA: Sólo la cubierta es acero inoxidable. Para una mayor durabilidad del producto, se recomienda darle un mantenimiento interior adecuado.



Acero inoxidable

GC-P101



Inferior, fijación a piso

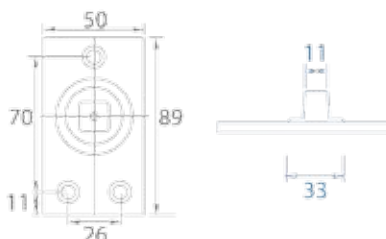

GC-P111



Superior, fijación a techo

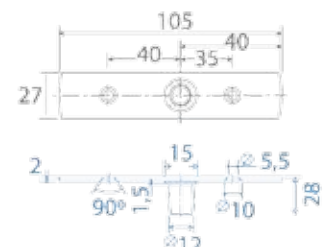

GalCen®
herrajes con clase...

El cristal necesita resaque para su fijación, se recomienda adquirir el producto antes de perforar el cristal.



Jaladeras

Jaladeras

Nuestras jaladeras le brindan el toque elegante que su puerta de cristal templado necesita, son pieza fundamental para cualquier espacio ya que es el herraje que tiene más contacto con las personas.

Calidad, fácil instalación y variedad en diseños adaptables a cualquier gusto.

Información

Material: Acero inoxidable

Acabado: Satin

Cristal de 6 a 12 mm.

SABÍAS QUÉ?

El acero inoxidable contiene un porcentaje de cromo y níquel, que funcionan como protección ante los agentes corrosivos.

Acero inoxidable

GC-H



"H"

Clave

	A	B	C
GC-H45	30cm	45cm	30mm
GC-H75	50cm	75cm	30mm
GC-H100	70cm	100cm	30mm
GC-H150	120cm	150cm	30mm

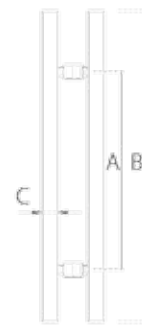

GC-HP



"H" punta

Clave

	A	B	C
GC-HP45	30cm	45cm	32mm
GC-HP100	70cm	100cm	32mm
GC-HP150	120cm	150cm	32mm

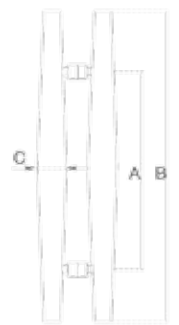

GC-H45C



"H" combinada

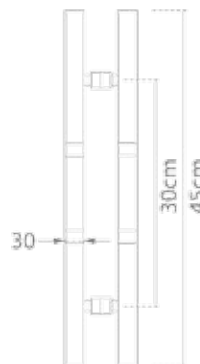

GC-H150CH



"H" chapa

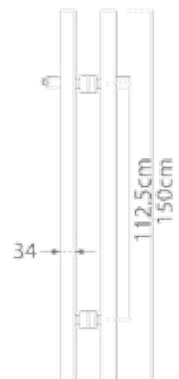



Jaladeras curvas

Información

Material: Acero inoxidable
Acabado: Satin, Cromo
Cristal de 6 a 12 mm.



Jaladeras pomodoro

Información

Material: Aluminio, latón
Acabado: Satin, cromo
Cristal de 6 a 12 mm.

Acero inoxidable

GC-H50PTS

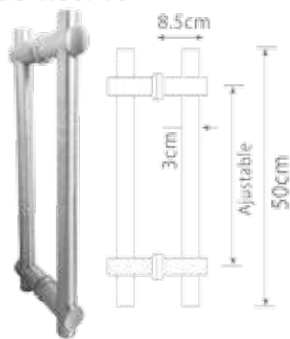

"H" 50 comb/pts.

GC-H50TUB

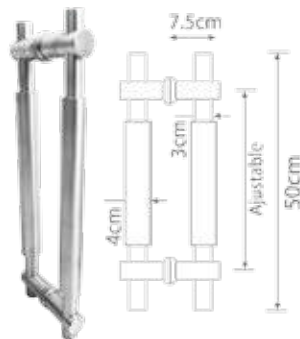

"H" 50 tubular

GC-H33CC

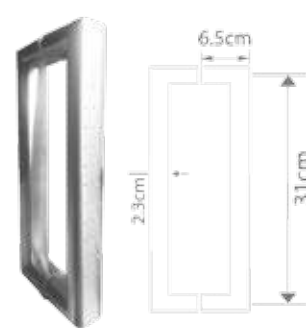

rectangular 33/pts.

GC-JALC



"C"



Clave	A	B
GC-JALC15	15cm	19cm
GC-JALC30	30cm	30cm

GC-HS45



"S"

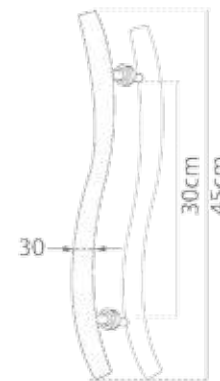

GC-TOWEL

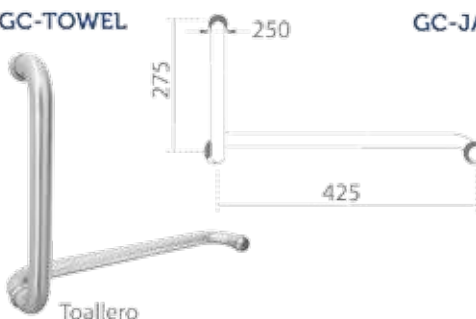

Toallero

GC-JALO / GC-JALOECO

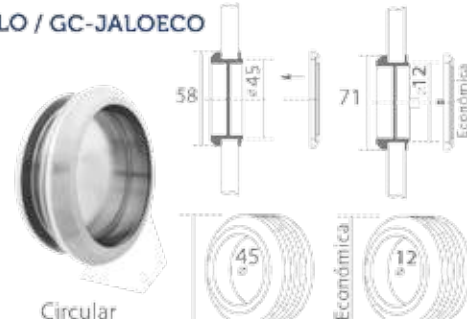

Circular

El cristal necesita resaque para su fijación, se recomienda adquirir el producto antes de perforar el cristal.

Aluminio y Latón

GC-POMO

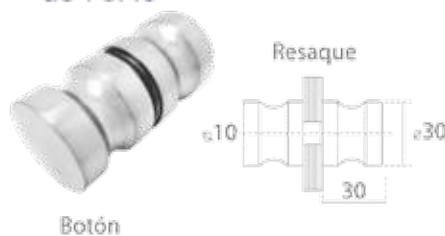

Botón

GC-POMOA



Botón aluminio

GC-POMO1



Cónica

GC-POMO1-A



Pomo aluminio



Pasamanos

Herrajes para pasamanos

Las escaleras y barandales dentro del diseño arquitectónico de viviendas, locales comerciales, culturales, deportivos, etc. Son importantes, para obtener circulaciones eficientes, espacios bien relacionados y recursos para darle mayor calidad al proyecto. Sobretudo si están hechos de cristal o acero inoxidable, ya que son adaptables a cualquier ambiente, Ofreciéndole modernidad y elegancia a cualquier espacio.

Información

Material: Acero inoxidable

Acabado: Satin

Bridas y tapas : "1 1/2" y "2"

Uniones: "2"

GC-BOT01, GC-BOT02 y GC-U07: barra de "1/2"

SABÍAS QUÉ?



Un vidrio común se rompe sin estructura definida dejando pedazos punzocortantes. El cristal templado se agrieta en minúsculos trozos que minimizan los riesgos de lesiones.

Acero inoxidable

GC-BRI01



Brida abierta

GC-BRI02



Brida de sobreponer

GC-TA01



Tapa base

GC-TA02



Tapa plana

GC-TA03



Tapa redonda

GC-TA04



Tapa con base

GC-BOT01



Botón para barra

GC-BOT02



Cabeza final

GC-U01



Cople unión

GC-U02



Unión articulada

GC-U03



Unión articulada

GC-U04



Unión 135°

GC-U05



Unión 90°

GC-U06



Tapa final

GC-U07



Conector ajustable

El cristal necesita resaque para su fijación, se recomienda adquirir el producto antes de perforar el cristal.



Postes

Información

Material: Acero inoxidable

Acabado: Satin

Cristal de 8 a 12 mm.

GC-POSTE , GC-POSTE2 Y PASAMANOS

Favor de cotizar medida.

Acero inoxidable

GC-POSTE3-A



Inicio

GC-POSTE3-B



Intermedio

GC-POSTE3-C



Esquinero

GC-POSTE



Tapa sencilla

GC-POSTE2



Tapa para pasamanos

GC-POSTE4-A



Inicio

GC-POSTE4-B



Intermedio

GC-POSTE4-C



Esquinero

Cromo

Satin

Cromo

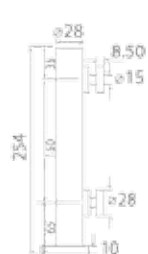

GC-MINI



Mini poste 25 cm.

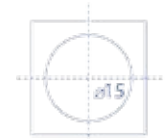
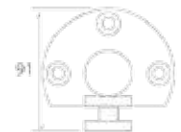

Resaque

GC-POSTE5-A



Inicio

GC-POSTE5-B



Intermedio

GC-POSTE5-C



Esquinero

GC-PASAMANOS



Calibre 18



Soportes

Información

Material: Acero inoxidable

Acabado: Satin

GC-SOPA: "1 1/2" y "2"

Acero inoxidable

GC-SOPORTE



Sujeción a vidrio



Resaque

GC-SOPORTE1



Curvo sujeción a vidrio

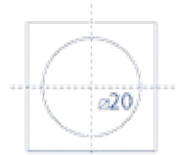

Resaque

GC-SOPORTEJ



"J" sujeción a muro

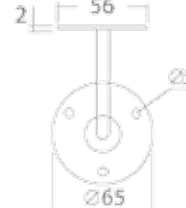

GC-SOPA



Sujeción a muro



GC-SOPA2



Sujeción a muro

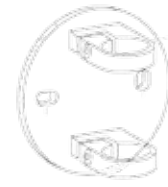

El cristal necesita resaque para su fijación, se recomienda adquirir el producto antes de perforar el cristal.



Los brazos estabilizadores Galcer®, hechos de acero inoxidable encajan de forma armoniosa y brindan un aspecto discreto en cualquier espacio. El minimalismo de forma acentuada hace su aportación en un ambiente de baño moderno.

Brazo estabilizador



La instalación es muy sencilla, ya que los brazos estabilizadores pueden ajustar su medida y no necesitan de resaque en el cristal.

Información

Material: Acero inoxidable

Acabado: Satin

Cristal de 8 a 12 mm.

Acero inoxidable

GC-BRA30



30cm.

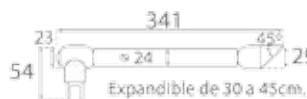

Expandible de 30 a 45cm.

GC-BRA60



60cm.



Expandible de 60 a 80cm.

Galcen
herrajes con clase...

El cristal necesita resaque para su fijación, se recomienda adquirir el producto antes de perforar el cristal.



Arañas

Arañas

Las arañas Galcen son la mejor opción para el diseño arquitectónico de fachadas, logrando espacios de gran dimensión, adoptando la forma geométrica de cualquier estructura, pero sobretodo ofrecerle un estilo único, elegante y de calidad a todas sus construcciones.

Información

Material: Acero inoxidable
Acabado: Satin, Cromo
Cristal de 8 a 12 mm.

SABÍAS QUÉ?



Aunque el vidrio se recicle, es importante conocer que no se biodegrada. Al ser inorgánico, puede permanecer en este planeta 4.000 años.

Acero inoxidable

GC-A201



Una pata
Sujeción a viga

GC-A202



Dos patas
Sujeción a viga

GC-A203

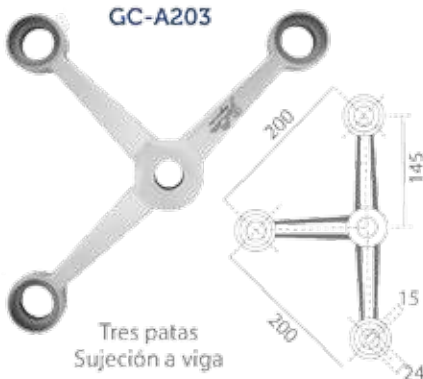

Tres patas
Sujeción a viga

GC-A204

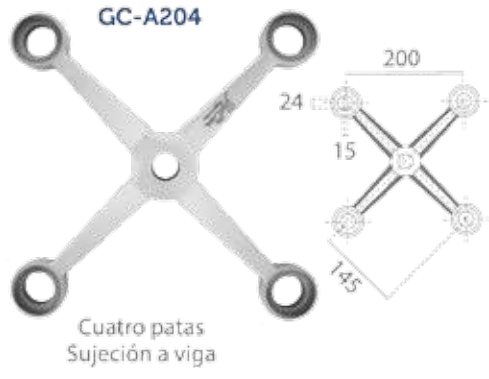

Cuatro patas
Sujeción a viga



Arañas porta costilla

Información

Material: Acero inoxidable
 Acabado: Satin, Cromo
 Cristal de 8 a 12 mm.

Acero inoxidable

GC-AP302S

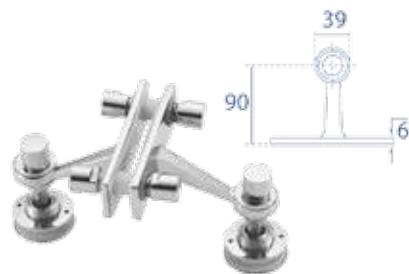

Dos patas Slim

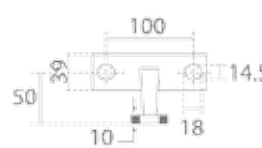

GC-AP304S



Cuatro patas Slim

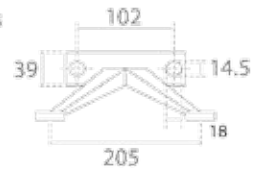

GC-AP302

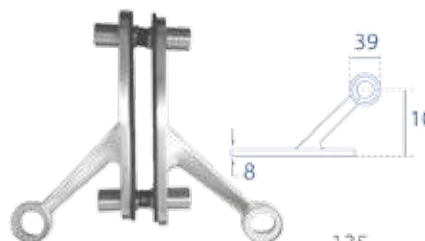

Dos patas

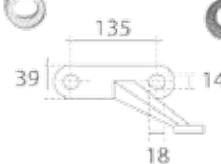

GC-AP304

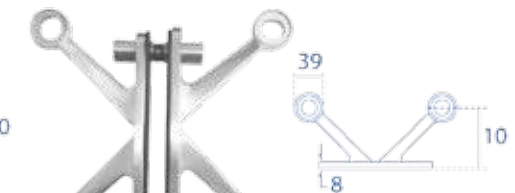

Cuatro patas

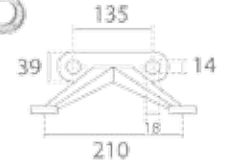

El cristal necesita resaque para su fijación, se recomienda adquirir el producto antes de perforar el cristal.

Rótulas



Información

Material: Acero inoxidable
 Acabado: Satin
 Cristal de 8 a 12 mm.

Acero inoxidable

GC-ROT10



Resaque recto



GC-ROT20



Resaque avellanado



GC-Z200



Conector a viga



Galcer®
herrajes con clase...

El cristal necesita resaque para su fijación, se recomienda adquirir el producto antes de perforar el cristal.

Canceles

Canceles de baño

Los canceles dentro de los cuartos de baño se han convertido en un elemento capaz de sorprender, de adecuarse perfectamente no sólo al espacio disponible sino también a las expectativas y necesidades de cualquier usuario. En Galcer® le ofrecemos los mejores canceles de baño, hechos con acero de la más alta calidad, variedad en su diseño, fácil instalación y el toque único y elegante que su baño se merece.

Información

Material: Acero inoxidable
Acabado: Satin, Cromo
Cristal de 8 a 12 mm.
1,50 y 2 mts.

SABÍAS QUÉ?

el vidrio no es un elemento sólido ya que se encuentra, en estado vítreo, lo cual quiere decir que es un líquido con una viscosidad muy alta que le da rigidez y dureza, haciéndolo parecer sólido.

GC-A002 / GC-A002B



Corredizo NEW STYLE

Acero inoxidable

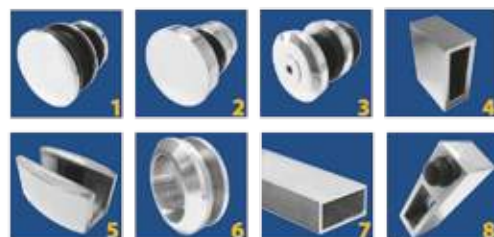

- 1.- Carretilla (2 pzas.)
- 2.- Botón (2 pzas.)
- 3.- Seguro (2 pzas.)
- 4.- Soporte (2 pzas.)
- 5.- Guía (1 pza.)
- 6.- Jaladera (1 pza.)
- 7.- Riel (1 pza.)
- 8.- Tope (2 pzas.)

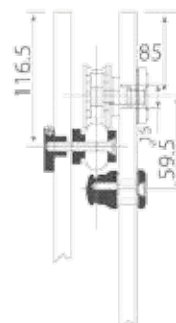
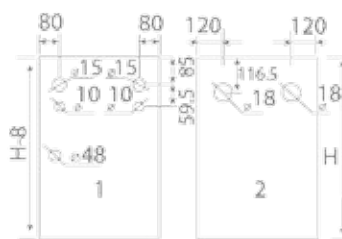
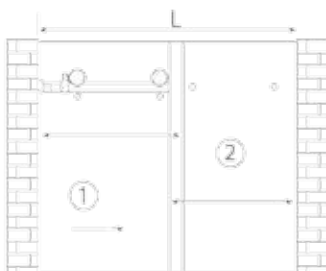



GC-A003

Acero inoxidable



Escuadra NEW STYLE



- 1.- Barra (2 pzas.)
- 2.- Carretilla (4 pzas.)
- 3.- Botón (4 pzas.)
- 4.- Unión (1 pza.)
- 5.- Soporte (2 pzas.)
- 6.- Tope (4 pzas.)
- 7.- Guía (2 pzas.)
- 8.- Jaladera (2 pzas.)
- 9.- Riel (1 pza.)

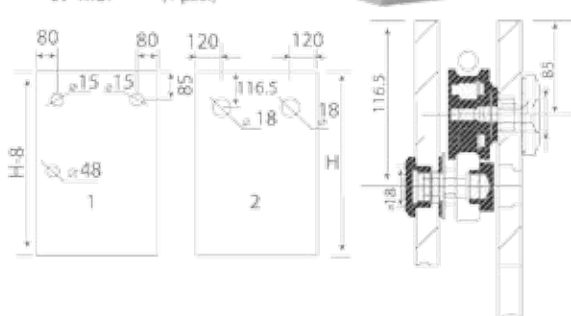
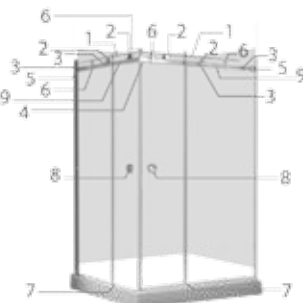

Cancel escuadra

Información

Material: Acero inoxidable
 Acabado: Satin, Cromo
 Cristal de 8 a 12 mm.
 1x1 mts.

El cristal necesita resaque para su fijación,
 se recomienda adquirir el producto antes de perforar el cristal.



GC-A005CRM / A005BCRM

Acero inoxidable



Corredizo



- 1.- Riel (2 pzas.)
- 2.- Perfil lateral (2 pzas.)
- 3.- Carretillas (4 pzas.)
- 4.- Guía (1 pza.)
- 5.- Topes (4 pzas.)
- 6.- Jaladera (2 pzas.)

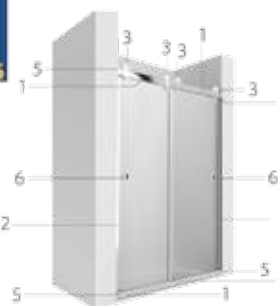

Cancel corredizo

Información

Material: Acero inoxidable / plástico / aluminio
 Acabado: Cromo
 Cristal de 6 a 8 mm.
 1.50 y 2 mts.

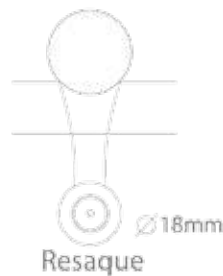
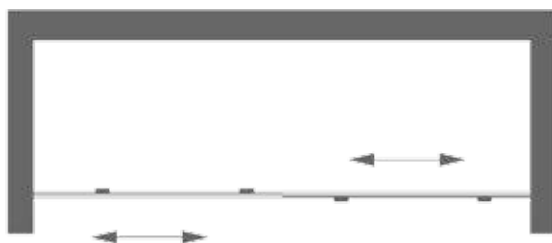

El cristal necesita resaque para su fijación, se recomienda adquirir el producto antes de perforar el cristal.

Sistemas

Sistemas

Contamos con una amplia gama de productos tanto de sistema alemán, como sistemas corredizos y plegables. Usted podrá elegir cual se apega mas a su estilo y diseño, además de que toda la variedad de productos están concebidos para ofrecer las mejores presentaciones en usos intensivos, haciéndolos idóneos para instalaciones en espacios públicos o privados.

Información

Material: Acero inoxidable
Acabado: Satin
Cristal de 8 a 12 mm.

SABÍAS QUÉ?

Una vez templado el cristal no se le podrá hacer ningún tipo de modificación.

Acero inoxidable

GC-B100

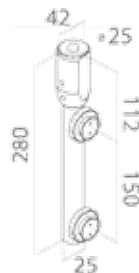

GC-B101

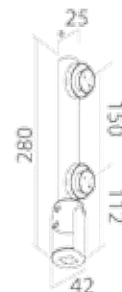

GC-B102

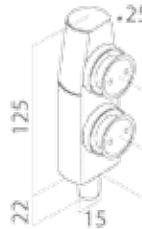

GC-B103

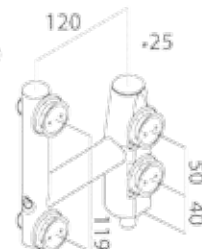

GC-B104

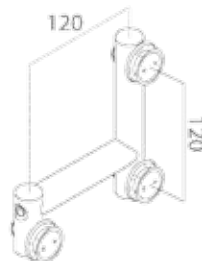



Corredizo embalado

Información

Material: Acero inoxidable

Acabado: Satin

Los kits incluyen 2 carretillas, 2 topes y 1 guía.

Riel: 3 y 5mts.



Corredizo

Información

Material: Acero inoxidable

Acabado: Satin

Cristal de 8 a 12 mm.

Carretillas: 120Kg. por par, resaque recto.

Acero inoxidable

GC-SC400



Kit de 100Kg.

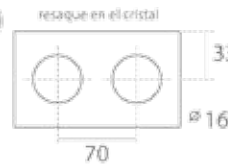

GC-SC401



Kit de 150Kg.

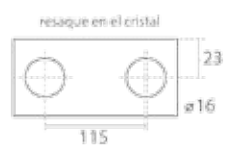

GC-SC403



Kit de 65Kg.

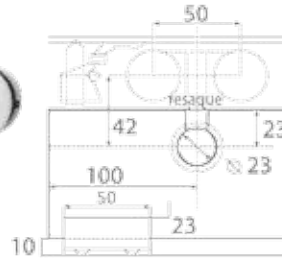

GC-SC404



Kit de 110Kg.

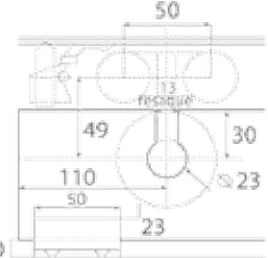

GC-SC402



Riel de aluminio

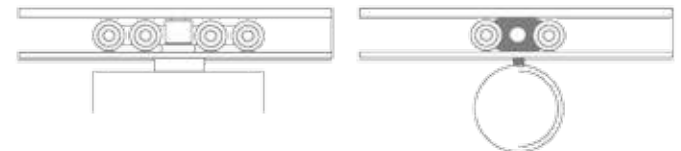

El cristal no necesita resaque para su fijación, se recomienda adquirir el producto antes de perforar el cristal.

GC-SC501



Carretillas

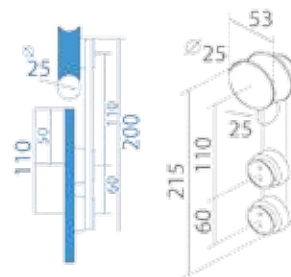

GC-SC502



Soporte barra a muro

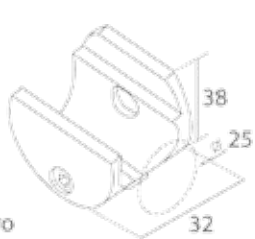

GC-SC502A



Soporte doble

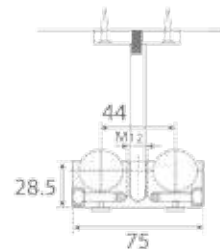

GC-SC503



Soporte barra a cristal

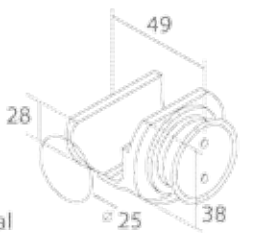

GC-SC504



Tope izquierdo o derecho

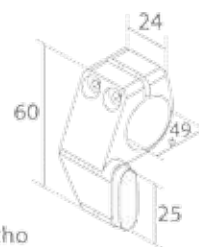

GC-SC505



Tope de lujo

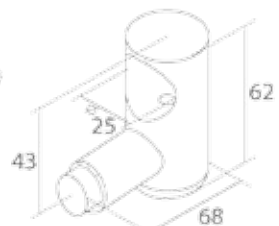

Acero inoxidable

GC-SC506



Conector barra a muro

GC-SC508



GC-SC507



Tapa de "1"



GC-SC509



Guía a piso

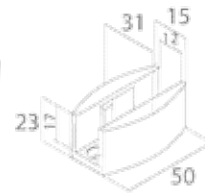

GC-SC510



Herramienta para sistema corredizo o conectores

Tubo de acero 3 y 6m

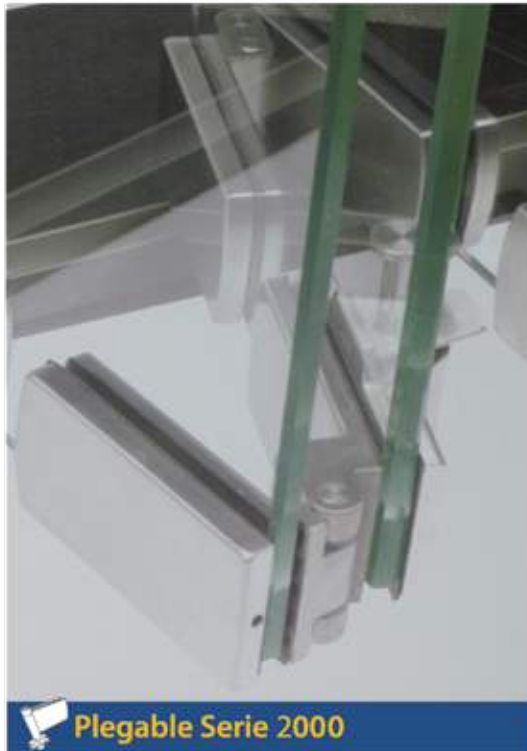

Plegable Serie 2000

Información

Peso del panel: 50 Kgs.
Núm de paneles máx: 4
Material: Acero inoxidable
Acabado: Satin
Cristal: 10 mm.
Ancho de panel: 850 mm.
Altura de panel: 2100 mm.
Riel: Aluminio, 3 mts.

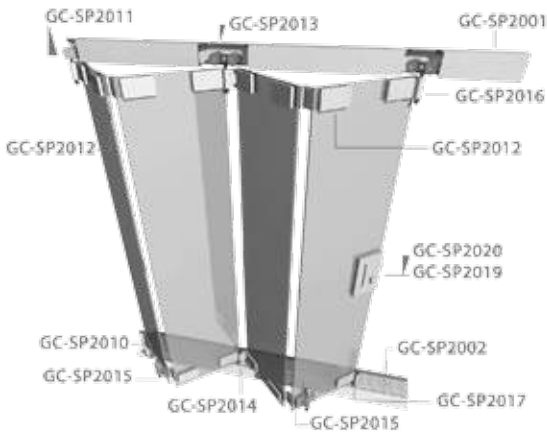

Acero inoxidable

El cristal necesita resaque para su fijación, se recomienda adquirir el producto antes de perforar el cristal.

GC-SP2010



Bisagra inicio inferior

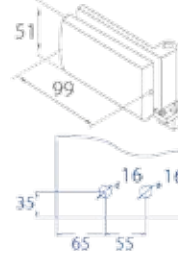

GC-SP2011



Bisagra inicio superior

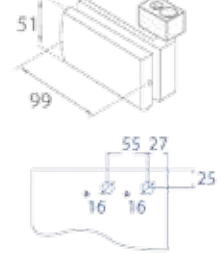

GC-SP2012



Bisagra doble intermedio superior o inferior

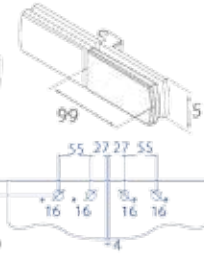

GC-SP2013



Bisagra doble superior

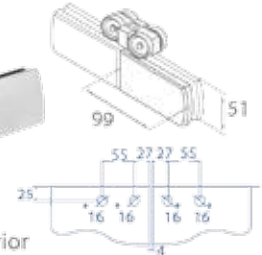

GC-SP2014



Bisagra inferior con guía

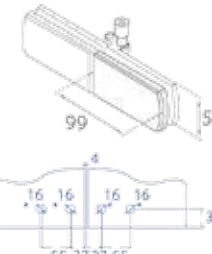

GC-SP2015



Bisagra doble con seguro

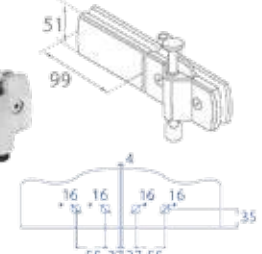

GC-SP2016



Bisagra final superior

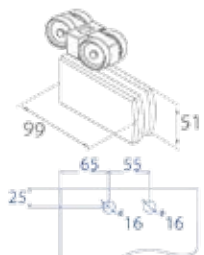

GC-SP2017



Bisagra final inferior con guía

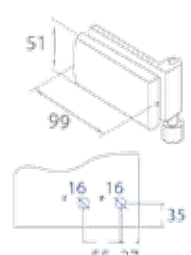

GC-SP2018



Seguro final Izq. o Der.

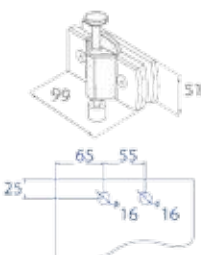

GC-SP2001



Riel superior

GC-SP2002



Riel inferior



Plegable Serie 3000

Información

Peso del panel: 85 Kgs. por hoja

Núm de paneles máx: Dependiendo del claro de la ventana

Material: Acero inoxidable

Acabado: Satin

Cristal: 10 mm.

Ancho de panel: 900 mm.

Altura de panel: 2500 mm.

La cantidad de producto puede variar dependiendo del número de paneles.

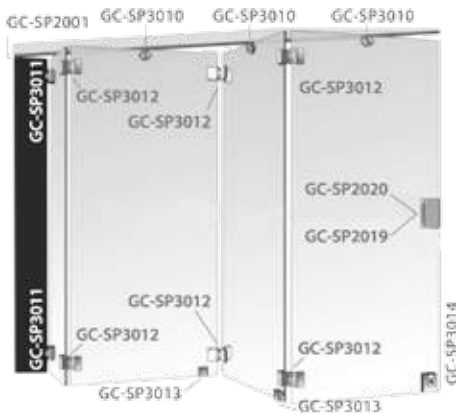

Acero inoxidable

GC-SP2019



Chapa

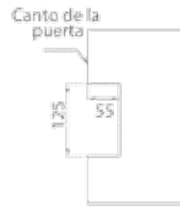

GC-SP2020



Contrachapa



GC-SP3010



Carretilla superior

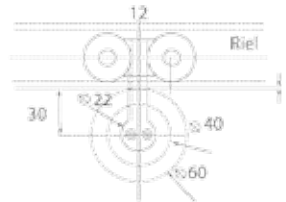

GC-SP3011



Bisagra inicial

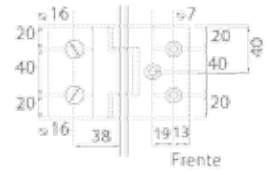

GC-SP3012



Bisagra intermedia

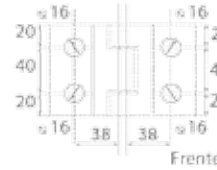

GC-SP3013



Chapa con mariposa



GC-SP3014



Chapa

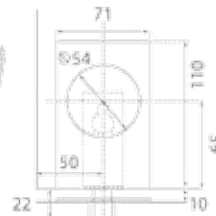

GC-SP3015



Botón

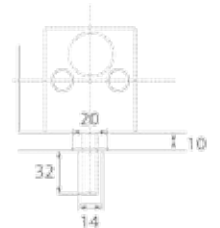

El cristal necesita resaque para su fijación,
se recomienda adquirir el producto antes de perforar el cristal.



El cristal necesita resaque para su fijación, se recomienda adquirir el producto antes de perforar el cristal.



Chapas

Chapas

Sabemos que su seguridad es lo más importante, es por eso que Galcer le ofrece una alta gama de chapas en acero inoxidable para puertas de cristal templado, cada una cumpliendo su función en seguridad, calidad y diseño.

Información

Material: Acero inoxidable
Acabado: Satin
Cristal de 8 a 12 mm.
Requiere resaque

SABÍAS QUÉ?



El Zamak es una aleación de Zinc, Aluminio, Magnesio y Cobre.

Acero inoxidable

GC-CH1200



Mariposa con
contrachapa



GC-CH1300

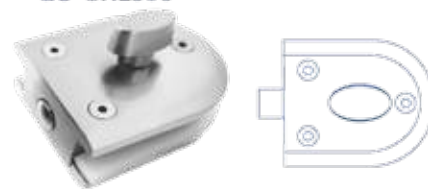

Sencilla con
mariposa



GC-CH1500



Doble manija



GC-CH1510



Doble manija con
contrachapa

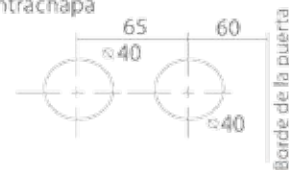

El resaque para la chapa y contrachapa es el mismo.



 **Chapas sin resaque**

Información

Material: Acero inoxidable

Acabado: Satin

Cristal de 8 a 12 mm.

CG-CHAVIT de 6 a 9 mm. / Cromo / Zamac

Acero inoxidable

GC-CH1000 / GC-CH1000ECO



Sencilla

GC-CH1050

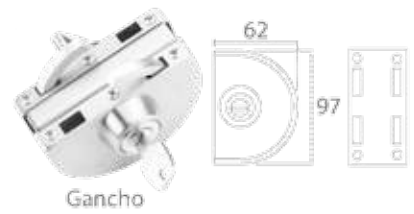

Gancho

GC-CH1100 / GC-CH1100ECO



Sencilla con contrachapa

GC-CH1150



Gancho con contrachapa

GC-CHAVIT

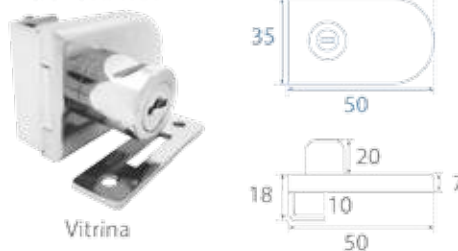

Vitrina

El cristal no necesita resaque para su fijación,
se recomienda adquirir el producto antes de perforar el cristal.

Descargue este catálogo a través de nuestro sitio web.



www.galcen.com



- Nosotros
- Productos
- Promociones
- y mucho más...

Síguenos en:



Gallen
herrajes con clase...

El cristal no necesita resaque para su fijación.

Perfiles

Perfiles de PVC

Mejore el aislamiento de su hogar y gane en eficiencia con nuestros perfiles de PVC. Estos se colocan en los extremos de puertas y ventanas para evitar las filtraciones de agua y aire. Son una solución sencilla y rápida de instalar, ya que no es necesario el uso de adhesivo o tornillo por lo que estos se pueden quitar o poner según sus necesidades.

Información

Material: PVC

Acabado: Translúcido

Cristal de 9mm

GC-PVCLAT y GC-PVCINT de 6 a 9mm. GC-PVCBOT de 10mm.

SABÍAS QUÉ?

El vidrio es un material inorgánico obtenido de la fusión a 1500°C de arena de sílice, carbonato de sodio y caliza.

PVC

GC-PVCLAT
GC-PVCLAT6



Lateral



GC-PVCINT
GC-PVCINT6



Intermedia



GC-PVCLAT2



Pared lateral



GC-PVCBURBUJA



Burbuja



GC-PVCIMAN



Imán 90° o 180°

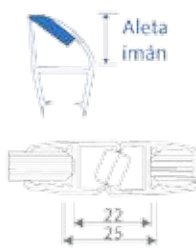

GC-PVCBOT



Botagua

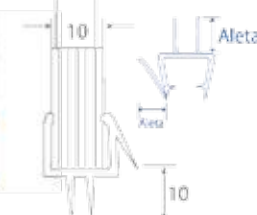



Accesorios

Accesorios para vidrio

Todo gran instalador de cristal necesita de herramientas que son útiles e indispensables para realizar su trabajo. Es por eso que Galcer® además de ofrecerle herrajes de las más alta calidad, tiene para usted accesorios que le facilitarán la instalación de vidrio en sus proyectos.

Información

Material: Plástico y metal

Acabado: Negro mate y amarillo

Cristal de 8 a 12 mm.

Accesorios para vidrio

GC-VENTL1



1 plato jumbo 150 kg.

GC-VENTL3



3 platos 120 kg.

GC-VENTE3



3 platos 100 kg.

GC-VENTL2



2 platos 80 kg.

GC-VENTE2



2 platos 60 kg.



Reciclar vidrio reduce la contaminación del aire en un 20%, y la contaminación del agua en un 50%.



Cortavidrios

Información

Material: plástico y metal

Cristal de 3 a 12 mm.

Escantillón y corta círculo: 1.20 mts.
estructura de aluminio

Accesorios para vidrio

GC-TOYO



Cortador

GC-CORTAECO



Cortador

GC-CORTAMED



Cortador

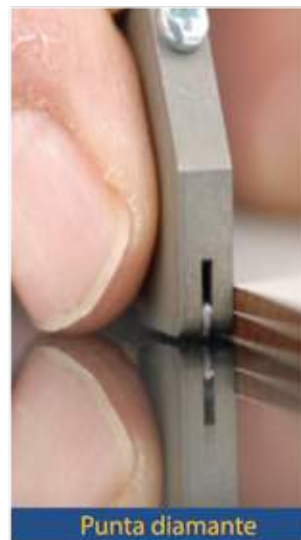

Punta diamante

GC-CIRCULO



Corta círculo

GC-ESCAN120



Escantillón

Soporte



Seguro



Punta diamante

Soporte



Seguro



Punta diamante

GalCen®
herrajes con clase...

Mejora tu estilo
refleja tu clase



Av. Mariano Escobedo 1402/Col.
Jardines de la Convención
C.P. 20260 Aguascalientes , Ags.

Tel: 01 (449) 9 70 52 50
01 (449) 9 70 87 87
01 (449) 9 70 52 54

Síguenos en:

